

### WITH STEPS REMOVABLE "U" TUBE BUNDLE

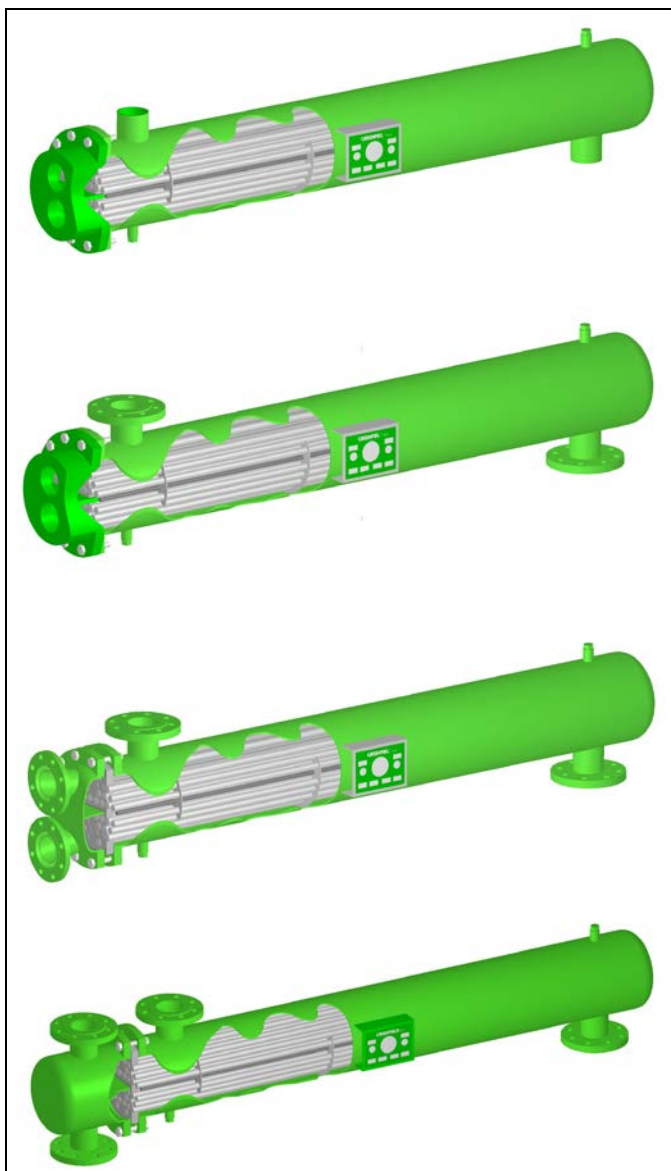

#### DESCRIPTION

The BEU series heat exchangers have been calculated and designed so that to obtain different models that differ in size and surface area. The baffles configuration, that characterize the shell internal geometry, allow to cover a very wide range of applications. They are available with 2 or 4 steps to ensure the most of the heat transfer fluids to be exchanged.

They are designed and built according to the following Directive: **PED 2014/68/UE** with basic calculation code EN13445 Part III; on request they can be designed according to ASME code VIII Div. 1 or AD2000.

They are classified with different categories, depending on the design pressure, on the the circuits or compartments volumes and on the fluid types.

The Directive provides for two groups::

Dangerous fluids Group 1

Non dangerous fluids Group 2

The Directive is exempt for pressure  $\leq 0.5$  bar.

In the following tables are defined the categories as a function of the fluid groups.

**WARNING !** According to a specific article of the Directive, when one of the compartments contains a fluid  $\geq$  to the first category and the second compartment contains a fluid falling in a higher category, the entire container assumes the highest category.

**ATEX 2014/34/UE II 2G/D cTx** – Non-electrical equipment for potentially explosive atmospheres.

They consist of a basic cylinder head 2 or 4 steps ( or more on request) , lowered with front connections, or cylindrical with perpendicular connections, of a shell and of a removable "U" tube bundle made of by "U" tubes just rolled or welded and rolled on a single plate. The typical configuration of the "U" tubes allows to absorb all thermal expansion created during the exchange process and ensure a perfect maintenance being the bundle tube removable

A proper configuration, grants a wide choice of materials including carbon steel and stainless steel; other materials are available on request.

The BEU Series exchanger is used for the heat exchange between various fluids in industrial processes or in civil processes of relevant potentiality. The advantages of a very low cost, easy inspection of the external circuit and easy maintenance, make it one of the most used heat exchange in industrial applications.

They are specially designed for industrial heat transfer fluids such as steam, hot water, thermal oil, water and other fluids.



**PED**  
Various modules  
CE 1214

**ATEX**  
II 2 G/D cTx  
CE 1370

## CONFIGURATION - materials

<b>Head</b>	Carbon Steel
	AISI 304 Stainless steel
	AISI 316 Stainless steel
	Other materials on request
<b>Gaskets</b>	Tecnograph GR th.. 3 mm
	Other materials on request
<b>Rods and nuts</b>	A193B7 + A194 2H
	A193B8 + A194 Gr.8
	A193 B8M + A194 Gr.8M
<b>Tune sheet</b>	Carbon Steel
	AISI 304 Stainless steel
	AISI 316 Stainless steel
	Other materials on request
<b>Tubes – pitch 24</b> Rolled on tube sheet Diathermic oil version Welded and rolled on tube sheet	Fe 35.2 Ø 18 x 1,5
	St. Steel AISI 304 A249 Ø 18 x 1 or 18 x 1,5
	St. Steel AISI 316 A249 Ø 18 x 1 or 18 x 1,5
	Other materials and dimensions on request
<b>Shell</b>	Carbon Steel
	AISI 304 Stainless steel
	AISI 316 Stainless steel
	Other materials on request
<b>Baffles</b>	Carbon Steel
	AISI 304 Stainless steel
	AISI 316 Stainless steel
	Other materials on request

### ACCESSORIES ON REQUEST

<b>Supports</b>	Carbon Steel
	AISI 304 Stainless steel
	AISI 316 Stainless steel
<b>Lifting eyebolts</b>	Carbon Steel
	AISI 304 Stainless steel
	AISI 316 Stainless steel

Sizes 1-2-3-4-5 are standardized with fixed number of baffles  
(example 211 06 - Ø168 with n° 6 baffles)

Sizes 6-7-8-9 are configurable.

# Products codification system follows at pag. 4

## Example code

VBEU	2	C	1	04	02	P12	18	C	X40	B	01
------	---	---	---	----	----	-----	----	---	-----	---	----

Series identification	N° steps		Head type		Ø exchanger		Exchanger lenght		N° baffles		Design pressure (bar) Tube side		Ø Tubes	
	2	4	F	R	1	2	04	05	04	05	P00	06	18	19
	2 steps	4 steps	Screwed	Lowered	Ø133	Ø168	400	500	4	5	0	06	18	19
	6 steps	8 steps	Cylindrical		Ø219	Ø273	700	900	6	8	10	10	25	25
					Ø324	Ø356	1100	1300	10	11	12	12	Y	Spec.
					Ø406	Ø456	1500	1600	12	13				
					Ø508		1800		14					
							1900		15					
							2000		16					
							2200		17					
							2300		18					
							2400		19					
							2500		20					
							2700		21					
							2800		22					
							2900		23					
							3100		24					
							3200		25					
							3300		26					
							3500		27					
							3600		28					
							3900		29					
							4100		30					
							4700		31					
							5200		32					
									33					
									34					
									35					
									36					
									37					
									38					
									39					
									1L	Longitudinal baffle				
									LD	Long. + baffle				



# Products codification system

Follows example code





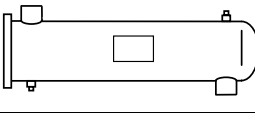
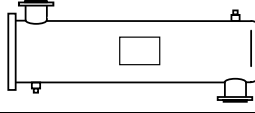

VBEU	2	C	1	04	02	P12	18	C	X40	B	01
------	---	---	---	----	----	-----	----	---	-----	---	----

Tube execution		Materials		Shell side connections		Supports	
<b>C</b>	Double undercut	<b>X40</b>	St. steel AISI304	<b>A</b>	Standard	<b>00</b>	Standard
<b>M</b>	Rolled						
<b>S</b>	Welded and rolled						
		<b>X30</b>	Tubes, sheets, shell A304 Other Carbon steel	<b>B</b>	1° Increase	<b>01</b>	Horizontal supports Carbon Steel
		<b>X20</b>	Tubes, sheets, shell A304 Other Carbon steel	<b>C</b>	2° Increase	<b>02</b>	Horizontal supports AISI304
		<b>X10</b>	Tubes, sheets A304 resto in Acc. Carb.	<b>D</b>	2 different connections	<b>03</b>	Horizontal supports Carbon st. eyebolts
		<b>X00</b>	Tubi AISI304 Other Carbon steel	<b>E</b>	3 connections	<b>04</b>	Horizontal supports AISI304 eyebolts
		<b>K40</b>	St. Steel AISI316	<b>M</b>	1° Decrease		
		<b>K30</b>	Tubes, sheets, shell A316 Other Carbon steel	<b>N</b>	2° Decrease		
		<b>K20</b>	Tubes, sheets, head A316 Other Carbon steel				
		<b>K10</b>	Tubes, sheets A316 Other Carbon steel				
		<b>K00</b>	Tubes AISI316 Other Carbon steel				
		<b>F00</b>	Tubes Fe Other Carbon steel				
		<b>C00</b>	Copper Tubes Other Carbon steel				
		<b>Y00</b>	Special materials				

## CONFIGURATION - PED – Design pressures and categories (tables–groups)

DRAWINGS EXPLANATION				
				
Front head Screwed connections	Front head Flanged connections	Cylindrical head flanged perpendicular connections	Shell Screwed connections	Shell Flanged connections

Side	Design pressure	Size 1			
		107 06	111 10	115 12	120 16



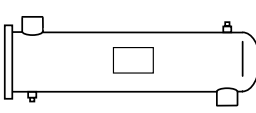
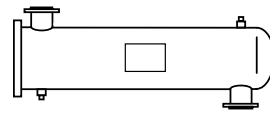





Tubes	Tab.3 Gr. 1	6 bar @ 350 °C						
			4/3					
	Tab.4 Gr. 2	12 bar @ 110 °C						
			4/3					
	Tab.2 Gr. 2	12 bar @ 191.7 °C						
			4/3					
			4/3			I°		
			4/3		I°			
								
					I°			
	16 bar @ 204,4 °C							
		I°						

Shell (1)					
	Tab.3 Gr. 1	6 bar @ 350 °C	4/3		
	Tab.4 Gr. 2	12 bar @ 110 °C	4/3		
	Tab.2 Gr. 2	12 bar @ 191.7 °C	I°		II°
	Tab.2 Gr. 2	16 bar @ 204,4 °C	I°		II°

Note (1) All shells are provided with Ø 1/2" Rp ISO 7 breather and drain connections

Technical note : minimum design temperature STD for all versions : 0 ° C



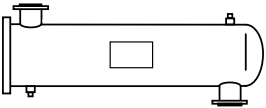





**CONFIGURATION - PED – Design pressures and categories (tables–groups)**











Side	Design pressure	Size 2					
		207 04	211 06	215 08	220 14		
<b>Tubes</b>	Tab.3 Gr. 1 6 bar @ 350 °C						
		4/3					
	Tab.4 Gr. 2 12 bar @ 110 °C						
		4/3					
	Tab.2 Gr. 2 12 bar @ 191.7 °C	4/3		I°			
				I°			
				I°			
				I°			
		16 bar @ 204,4 °C		I°		II°	
		25 bar @ 226.1 °C		II°			
<b>Shell (3)</b>							
	Tab.3 Gr. 1 6 bar @ 350 °C	4/3					
	Tab.4 Gr. 2 12 bar @ 110 °C	4/3					
	Tab.2 Gr. 2 12 bar @ 191.7 °C	I°	II°				
	Tab.2 Gr. 2 16 bar @ 204,4 °C	II°					

Note (1) All shells are provided with Ø 1/2" Rp ISO 7 breather and drain connections

Technical note : minimum design temperature STD for all versions : 0 ° C

**CONFIGURATION - PED – Design pressures and categories (tables–groups)**

Side		Design pressure	Size 3				
			309 06	311 08	315 10	320 16	
<b>Tubes</b>	Tab.3 Gr. 1	6 bar @ 350 °C	 4/3 				
	Tab.4 Gr. 2	12 bar @ 110 °C	 4/3 				
	Tab.2 Gr. 2	12 bar @ 191.7°C		I°		II°	
				I°	II°		
		16 bar @ 204,4 °C		II°			
	25 bar @ 226.1 °C		II°				
<b>Shell (1)</b>	Tab.3 Gr. 1	6 bar @ 350 °C	4/3		I°		
	Tab.4 Gr. 2	12 bar @ 110 °C	4/3				
	Tab.2 Gr. 2	12 bar @ 191.7 °C	II°				
	Tab.2 Gr. 2	16 bar @ 204.4 °C	II°				







Side		Design pressure	Size 4				
			411 06	415 08	420 10	424 16	
<b>Tubes</b>	Tab.3 Gr. 1	6 bar @ 350 °C	 4/3 		 I° 		
	Tab.4 Gr. 2	12 bar @ 110 °C	 4/3 				
	Tab.2 Gr. 2	12 bar @ 191.7°C		II°			
				II°			
		16 bar @ 204,4 °C		II°			
	25 bar @ 226.1 °C		II°		II° (2)		
<b>Mantello (1)</b>	Tab.3 Gr. 1	6 bar @ 350 °C	4/3			I°	
	Tab.4 Gr. 2	12 bar @ 110 °C	4/3				
	Tab.2 Gr. 2	12 bar @ 191.7 °C	II°			II° (2)	
	Tab.2 Gr. 2		II° 16 bar @ 204,4°C		III° 16 bar @ 205 °C / or II° (2)		

Note (1) All shells are provided with Ø 1/2" Rp ISO 7 breather and drain connections







Note (2) Declass PS

Technical note : minimum design temperature STD for all versions : 0 ° C

**CONFIGURATION - PED – Design pressures and categories (tables–groups)**

Side		Design pressure		Size 5			
				511 06	515 08	520 10	524 16
<b>Tubes</b>	Tab.3 Gr. 1	6 bar @ 350 °C		 <span style="border: 1px solid black; padding: 2px;">I°</span> 			
	Tab.4 Gr. 2	12 bar @ 110 °C		 <span style="border: 1px solid black; padding: 2px;">4/3</span> 			
	Tab.2 Gr. 2	12 bar @ 191.7°C		II°			
				II°			
				II° 16 bar @ 204.4 °C		III° 16 bar @ 205°C	
<b>Shell(1)</b>	Tab.3 Gr. 1	6 bar @ 350 °C		I°			
	Tab.4 Gr. 2	12 bar @ 110 °C		4/3			
	Tab.2 Gr. 2	12 bar @ 191.7 °C		II°	II° (2)		
	Tab.2 Gr. 2	16 bar @ 205 °C		III°			





Side		Design pressure		Size 6						
				615	616	619	622	625	628	631
<b>Tubes</b>	Tab.3 Gr. 1	6 bar @ 350 °C		 <span style="border: 1px solid black; padding: 2px;">I°</span> 						
	Tab.4 Gr. 2	12 bar @ 110 °C		 <span style="border: 1px solid black; padding: 2px;">4/3</span> 						
	Tab.2 Gr. 2	12 bar @ 191.7°C		II°				III°		
				II° 16 bar @ 204.4 °C	III°					
		16 bar @ 205 °C		III°						
<b>Shell (1)</b>	Tab.3 Gr. 1	6 bar @ 350 °C		I°						
	Tab.4 Gr. 2	12 bar @ 110 °C		4/3						
	Tab.2 Gr. 2	12 bar @ 191.7 °C		II° (2)						
	Tab.2 Gr. 2	16 bar @ 205 °C		III°					IV°	





Note (1) All shells are provided with Ø 1/2" Rp ISO 7 breather and drain connections  
 Nota (2) Declass PS

Technical note : minimum design temperature STD for all versions : 0 ° C



**CONFIGURATION - PED – Design pressures and categories (tables–groups)**

Side		Design pressure	Size 7					
			718	720	723	725	729	733
Tubes	Tab.3 Gr. 1	6 bar @ 350 °C						
	Tab.2 Gr. 2	12 bar @ 110 °C						
	Tab.2 Gr. 2	12 bar @ 191.7 °C						
								
		16 bar @ 205 °C						
Shell (1)	Tab.3 Gr. 1	6 bar @ 350 °C	I°					
	Tab.4 Gr. 2	12 bar @ 110 °C	4/3					
	Tab.2 Gr. 2	16 bar @ 205 °C	III°			IV°		

Side		Design pressure	Size 8					
			820	822	825	829	832	835
Tubes	Tab.3 Gr. 1	6 bar @ 350 °C						
	Tab.4 Gr. 2	12 bar @ 110 °C						
	Tab.2 Gr. 2	16 bar @ 205 °C						
Shell (1)	Tab.3 Gr. 1	6 bar @ 350 °C	I°					
	Tab.4 Gr. 2	12 bar @ 110 °C	4/3					
	Tab.2 Gr. 2	16 bar @ 205 °C	IV°					

Side		Design pressure	Size 9						
			920	923	925	928	931	936	941
Tubes	Tab.3 Gr. 1	6 bar @ 350 °C							
	Tab.4 Gr. 2	12 bar @ 110 °C							
	Tab.2 Gr. 2	16 bar @ 205 °C							
Shell (1)	Tab.3 Gr. 1	6 bar @ 350 °C	I°						
	Tab.4 Gr. 2	12 bar @ 110 °C	4/3						
	Tab.2 Gr. 2	16 bar @ 205 °C	IV°						

Note (1) All shells are provided with Ø 1/2" Rp ISO 7 breather and drain connections

Nota (2) Declass PS

Technical note : minimum design temperature STD for all versions : 0 ° C

**Models - Dimensions in mm, Connections and Weight in Kg.**

**Size 1 Models configuration – “ P12 - P16 ”**

<b>Mod.</b>	<b>107 06</b>	<b>111 10</b>	<b>115 12</b>	<b>120 16</b>	<b>Mod.</b>	<b>107 06</b>	<b>111 10</b>	<b>115 12</b>	<b>120 16</b>	
<b>Weight Kg</b>	37	49	61	73	<b>Weight Kg</b>	43	55	67	79	
<b>Mod.</b>	<b>107 06</b>	<b>111 10</b>	<b>115 12</b>	<b>120 16</b>	<b>Mod.</b>	<b>107 06</b>	<b>111 10</b>	<b>115 12</b>	<b>120 16</b>	
<b>Weight Kg</b>	40	52	64	76	<b>Weight Kg</b>	46	58	70	82	
<b>Model</b>	<b>107 06</b>			<b>111 10</b>			<b>115 12</b>			<b>120 16</b>
<b>Weight Kg</b>	42			54			66			78

**Female Gas Thread According to ISO Rp 7 - Flanges according to EN 1092-1 (Other executions on request)**

Size	Mod.	ØD	Head connections				Shell connections			
			T1 - T2		T3 - T4	T5-T6	S1 - S2	S3 - S4	S3 - S4	
			2 steps	4 steps	2 - 4 steps				I° increase	II° increase
1	107	133	Ø 1.1/2" Gas	Ø 1.1/4" Gas	DN 40 PN 16	DN 40 PN 40 (1)	Ø 2" Gas	DN 50 PN 16 (2)	DN 65 PN 16 (2)	DN 80 PN 16 (2)
	111									
	115									
	120									

(1) If the cylindrical head has design pressure P06 - 6 bar @ 350 ° C, the flange connections are PN 16

(2) If the shell has design pressure 16 bar @ 204.4 the flange is PN 40

Size	Mod.	ØD	A	A1	A2	B	C	a	a1	H	H1	L	L1	L2
1	107	133	161	221	306	580	100	58	151	237	270	856	916	1001
	111					980						1256	1316	1401
	115					1380						1656	1716	1801
	120					1880						2156	2116	2301

# Models - Dimensions in mm, Connections and Weights in Kg.

## Size 2 Models configurations – “ P12 – P16 “

<b>Mod.</b>	207 04	211 06	215 08	220 14	<b>Mod.</b>	207 04	211 06	215 08	220 14
<b>Weight Kg</b>	59	65	78	93	<b>Weight Kg</b>	59	65	77	93
<b>Model</b>	207 04	211 06		215 08		220 14			
<b>Weight Kg</b>	64	70		82		98			

Female Gas Thread According to ISO Rp 7 - Flanges according to EN 1092-1 (Other executions on request)

Size	Mod.	ØD	Head connections				Shell connections		
			T1 - T2		T3 - T4	T5-T6	S3 - S4	S3 - S4	
			2 steps	4 steps	2 - 4 steps			I° increase	II° increase
2	207	168	Ø 2" Gas	Ø 1.1/2" Gas	DN 50 PN 16	DN 50 PN 40 (1)	DN 65 PN16 (2)	DN 80 PN16 (2)	DN 100 PN16 (2)
	211								
	215								
	220								

- (1) If the cylindrical head has design pressure P06 - 6 bar @ 350 ° C, the flange connections are PN 16  
 (2) If the shell has design pressure 16 bar @ 204.4 the flange is PN 40

Size	Mod.	ØD	A	A1	A2	B	C	a	a1	H	L	L1	L2
2	207	168	191	286	386	540	135	70	167	320	851	946	1046
	211					940					1251	1346	1446
	215					1340					1651	1746	1846
	220					1840					2151	2246	2346

# Models - Dimensions in mm, Connections and Weights in Kg.

## Sizes 3 / 4 / 5 / 6 / 7 Models configurations – “ P12 – P16 “

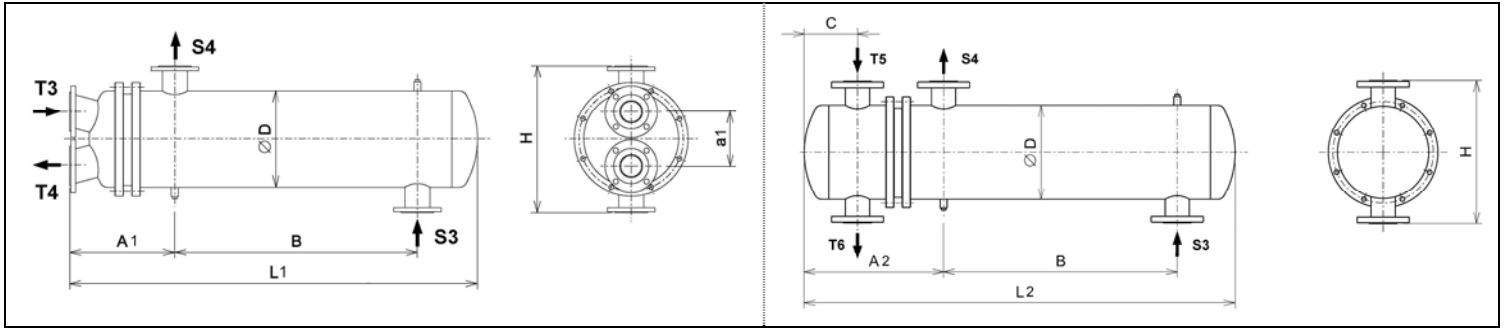

### Flanges according EN 1092-1 (Other executions on request)

Size	Model	Ø D	A1	A2	B	C	a1	H	L1	L2	Head conn.		Shell connections			Weight Kg						
											T3-T4	T5-T6	S3 - S4	S3 - S4		P12 lower head	P16 cylindrical head					
											N° steps			Increase								
											2 - 4			I°	II°							
3	309 06	219	284	399	718	140	190	380	1159	1274	DN65	DN65	DN80	DN 100	DN 125	91	97					
	311 08				918				1359	1474						PN16	PN40 (1)	PN16 (2)	PN 16 (2)	PN16 (2)	100	106
	315 10				1318				1759	1874											119	125
	320 16				1818				2259	2374											144	150
4	411 06	273	335	474	886	164	210	460	1393*	1532*	DN80	DN80	DN100	DN 125	DN 150	128	140					
	415 08				1286				1793*	1932*						PN16	PN40 (1)	PN16 (2)	PN 16 (2)	PN16 (2)	154	166
	420 10				1786				2293*	2432*											188	200
	424 16				2186				2693*	2832*											214	226
5	511 06	324	392	567	850	205	222	540	1456*	1631*	DN 100	DN 100	DN 125	DN 150	DN 200	163	180					
	515 08				1250				1856*	2031*						PN16	PN40 (1)	PN16 (2)	PN 16 (2)	PN16 (2)	213	230
	520 10				1750				2356*	2531*											261	278
	524 16				2150				2756*	2931*											297	314
6	615	356	420	585	1245	225	252	580	1889*	2054*	DN 125	DN 125	DN 150	DN 200	DN 250	300	316					
	616				1345				1989*	2154*						PN16	PN40 (1)	PN16 (2)	PN 16 (2)	PN16 (2)	312	328
	619				1645				2289*	2454*											348	364
	622				1945				2589*	2754*											384	400
	625				2245				2889*	3054*											420	436
	628				2545				3189*	3354*											456	472
	631				2845				3489*	3654*											492	508
7	718	406	562	640	1545	260	287	640	2348*	2430*	DN 150	DN 150	DN 150	DN 200	DN 250	435	460					
	720				1745				2548*	2630*						PN16	PN40 (1)	PN16 (2)	PN16 (2)	PN16 (2)	465	490
	723				2045				2848*	2930*											510	535
	725				2245				3048*	3130*											546	565
	729				2645				3448*	3530*											606	625
	733				3045				3848*	3930*											666	685

N.A. = Not Applicable

\* AISI 304/316 version : see constructive drawing

- (1) If the cylindrical head has design pressure P06 - 6 bar @ 350 ° C, the flange connections are PN 16
- (2) If the shell has a design pressure of 16 bar @ 205, the flange is PN 40

**Models - Dimensions in mm, Connections and Weights in Kg.**

**Size 8 / 9 Models configuration - " P16 "**

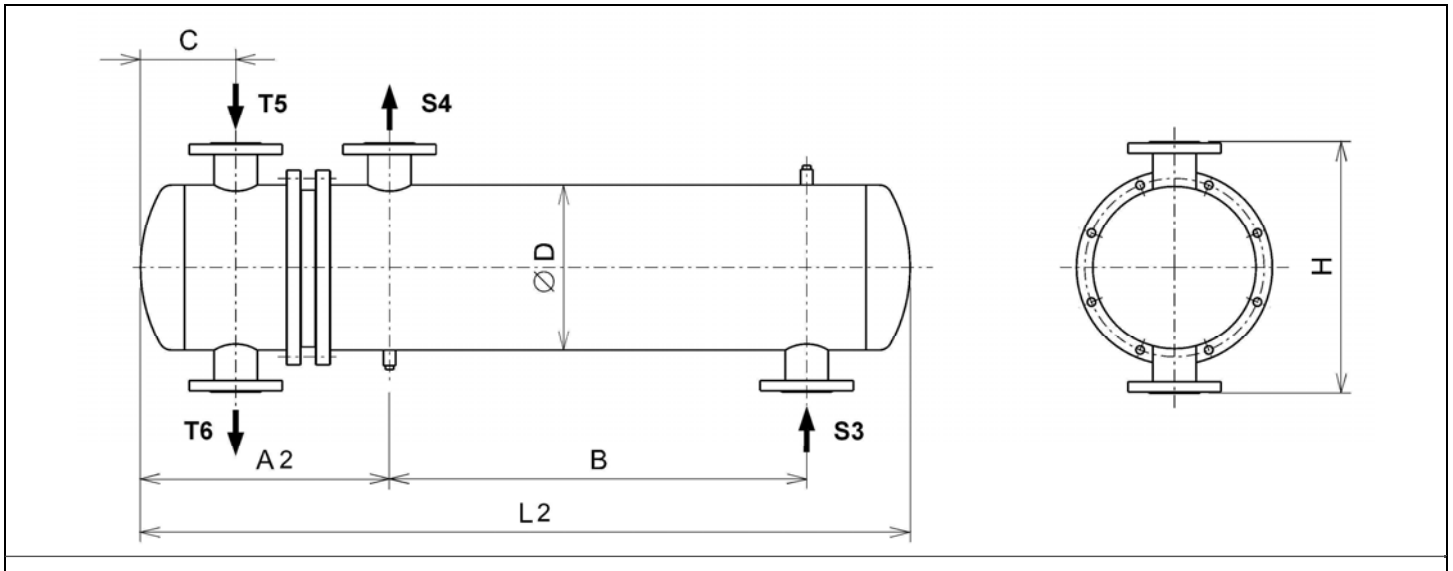

**Flanges according to EN 1092-1 (other executions on request)**

Size	Mod.	ØD	A2	B	C	H	L2 Carb.	L2 Inox	Head conn.		Shell connections		Weight Kg	
									T5 - T6		S3 - S4	S3 - S4		
									N° steps			Increase		
									2 - 4			I°		II°
8	820	457	690	1755	290	690	2889	2890	DN 200 PN 40 (1)	DN 200 PN 16 (2)	DN 250 PN 16 (2)	DN 300 PN16 (2)	718	
	822			1955			3089	3090					764	
	825			2255			3389	3390					833	
	829			2655			3789	3790					925	
	832			2955			4089	4090					994	
	835			3255			4389	4390					1063	
	839			3655			4789	4790					1155	
9	920	508	733	1640	310	760	2819	2825	DN 200 PN 40 (1)	DN 200 PN 16 (2)	DN 250 PN 16 (2)	DN 300 PN 16 (2)	910	
	923			1940			3119	3125					1005	
	925			2140			3319	3325					1070	
	928			2440			3619	3625					1165	
	931			2740			3919	3925					1260	
	936			3240			4419	4425					1420	
	941			3740			4919	4925					1580	
	947			4340			5519	5525					1770	
	952			5840			6019	6025					1930	

- (1) If the cylindrical head has design pressure P06 - 6 bar @ 350 ° C, the flange connections are PN 16  
 (2) If the shell has design pressure 16 bar @ 205, the flange connections are PN 40

**Models - Dimensions in mm, Connections and Weights in Kg.**

**Size 2 – 4 – 5 – 6 Model configuration - “ P25 “**

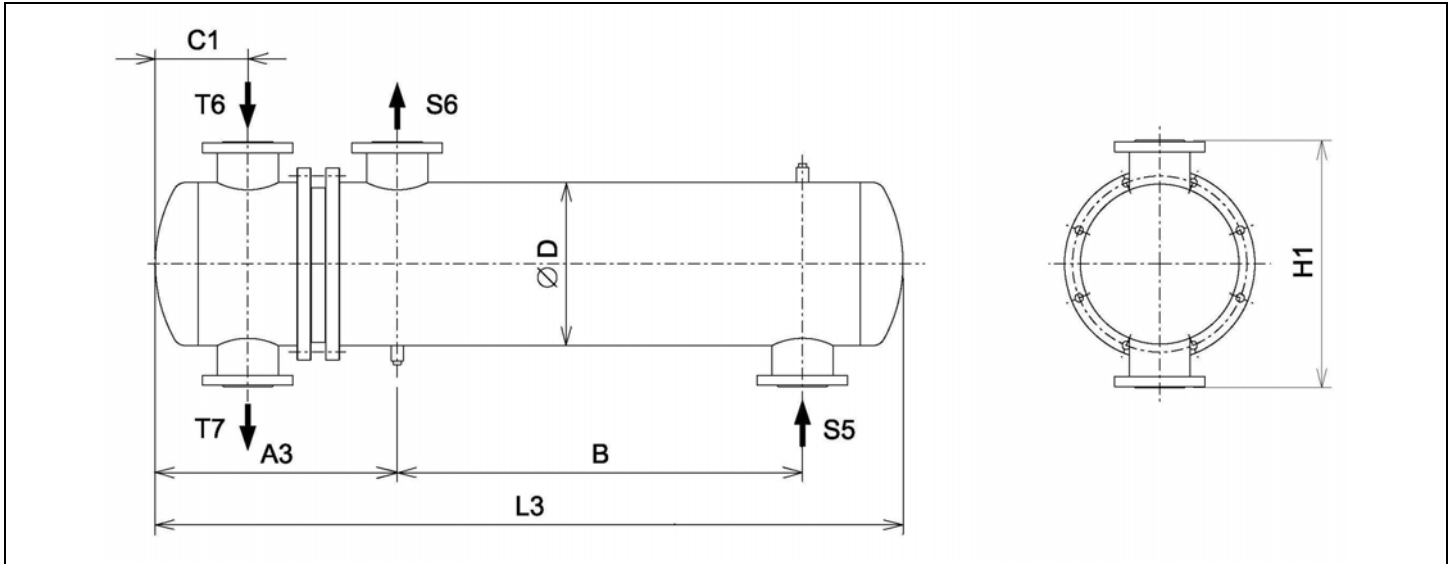

**Flanges according to EN 1092-1 (Other executions on request)**

Size	Model	ØD	A3	B	C1	H1	L3	Head conn.		Shell connections			Weight Kg
								T6 – T7		S5 – S6	S5 – S6		
								N° Steps			Increase		
								2 - 4			I°	II°	
2	207	168	390	540	135	320	1050	DN 50 PN 40	DN 65 PN 16 (1)	DN 80 PN 16 (1)	DN 100 PN16 (1)	64	
	209			740								1250	67
	211			940								1450	70
	213			1140								1650	76
	215			1340								1850	82
	218			1640								2150	92
	220			1840								2350	98
	3			309								219	405
311		918	1480	106									
313		1118	1680	115									
315		1318	1880	125									
318		1618	2180	140									
320		1818	2380	150									
4	409	273	479	686	164	460	1424	DN 80 PN 40	DN 100 PN 16 (1)	DN 125 PN 16 (1)	DN 150 PN 16 (1)	127	
	411			886								1624	140
	413			1086								1824	153
	415			1286								2024	166
	418			1586								2324	186
	420			1786								2524	200
	424			2186								2924	226

(1) If the shell has a design pressure of 16 bar @ 205, the flange connections are PN 40

**Pair of saddle supports – Valid for all models - Dimensions in mm and Weight in Kg.  
Calculation code ASME VIII Div. 1 Ed. 2015**

- In accordance with the Ordinance n° 3274 dated 20.03.03 GAZZETTA UFFICIALE DELLA REPUBBLICA ITALIANA  
External environment **EARTHQUAKE seismic zones 1 – 2 – 3 – 4 on the ground of category "A"**
- In conformity to D.M. LL. PP. dated 16 January 1996 and Circ. LL. PP. dated 4 July 1996  
External environment **WIND – areas 1 – 2 – 3 – 4 – 5 – 6 – 7 – 8 Class A–B–C–D Category I–II–III–IV–V**

<p style="text-align: center;"><b>MISURE 1</b></p>	<p style="text-align: center;"><b>MISURE 2</b></p>	<p style="text-align: center;"><b>MISURE 3</b></p>
<p style="text-align: center;">Pair or support weight Kg. 3.4</p>	<p style="text-align: center;">Pair or support weight Kg. 3.2</p>	<p style="text-align: center;">Pair or support weight Kg. 6</p>
<p style="text-align: center;"><b>MISURE 4</b></p>	<p style="text-align: center;"><b>MISURE 5</b></p>	<p style="text-align: center;"><b>MISURE 6</b></p>
<p style="text-align: center;">Pair or support weight Kg. 7.7</p>	<p style="text-align: center;">Pair or support weight Kg. 10</p>	<p style="text-align: center;">Pair or support weight Kg. 33.2</p>
<p style="text-align: center;"><b>MISURE 7</b></p>	<p style="text-align: center;"><b>MISURE 8</b></p>	<p style="text-align: center;"><b>MISURE 9</b></p>
<p style="text-align: center;">Pair or support weight Kg. 33.6</p>	<p style="text-align: center;">Pair or support weight Kg. 47.7</p>	<p style="text-align: center;">Pair or support weight Kg. 48.2</p>

## SKID solutions – ASSEMBLY with PED 2014/68/UE conformity



The preassembled “skid” units – “assembly” are complete units, integrated with control panel. They are conform to PED 2014/68/UE with Declaration of Conformity Assemblee CAT. IV CE marked with Notified Body number, exempt from commissioning audit according to art.5 del D.M. 1 December 2044 n° 329. They are used for hot water and superheated water production, with primary heat transfer fluid: thermal oil – Superheated water – Steam.

### Main characteristics :

• <b>BASEMENT</b>	<i>Carbon steel U profile RAL 6011 painted – UNP 240 x 80 RAL 6011 painted – Palletized and with eyebolts</i>
• <b>ELECTRICAL CONTROL PANEL</b>	<i>Electrical control panel RAL 7032 painted or st. steel AISI 304, with Siemens PLC or electromechanical</i>
• <b>CONNECTIONS</b>	<i>Electric or pneumatic to pneumatic valves and to the other equipments</i>
• <b>INSULATION</b>	<i>Heat exchanger – Pipelines except the valves, with rock wool th.50 mm density 100 Kg/dm<sup>3</sup> with covering of aluminum sheet 8/10, openings with stainless steel screws</i>
• <b>PIPELINES</b>	<i>Carbon steel ASTM A106 gr. B API5L sch. 40 – painted with a coat of rust inhibitor and a coat for high temperature – Carbon steel flanges EN 1092-1 PN16 o PN40 – Carbon steel fittings – Armed graphite gaskets.</i>
• <b>COMPONENTS</b>	<i>High quality from CONFLOW SpA products range</i>

